

How To Select The Right Laboratory Hood System



Protecting your
laboratory environment

LABCONCO

An Industry Service Publication

For more information, please contact us:

[ExpotechUSA](#)

[10700 Rockley Road](#)
[Houston, Texas 77099](#)
[USA](#)

[281-496-0900 \[voice\]](#)

[281-496-0400 \[fax\]](#)

E-mail: sales@expotechusa.com

Website: www.ExpotechUSA.com

Foreword

This booklet has been developed to serve as an aid in selecting a laboratory fume hood ventilation system. The information is intended to be unbiased and generic in nature, compiled with help from experienced architects, laboratory consultants, engineers and laboratory hood users. The basic understanding of hood systems you gain from reviewing this booklet should prove valuable to you as you discuss your needs with safety officers, engineers and hood manufacturers.

Our Method

The table of contents outlines the various issues that are addressed in this booklet. As you read through the material, remember you are selecting a laboratory hood system. A fume hood does not function alone. A variety of factors external to a hood influences its performance. Likewise, a hood and the applications performed inside it can also affect its surroundings. When selecting a fume hood, you must consider the whole picture — the laboratory space, the building's ventilation system, the hood's location in the room, to name a few.

While this booklet will raise the questions necessary to identify your specific hood requirements, it may not answer those questions. Only you, your safety officer or industrial hygienist, and a qualified design consultant can identify your laboratory's unique challenges.

We want this document to expand and improve over time. If you have suggestions for additions or improvements to this guide, please write Labconco Corporation, 8811 Prospect Avenue, Kansas City, MO 64132. Call 800-821-5525 or 816-333-8811. Or e-mail labconco@labconco.com.

Table of Contents

Selecting The Proper Enclosure	
What is a Laboratory Fume Hood?	3
Laboratory Exhaust Systems and Types of Laboratory Hoods	
Constant Air Volume (CAV) — Conventional, By-Pass, High Performance, Auxiliary-Air, Reduced Air Volume (RAV)	3
Variable Air Volume (VAV)	5
Special Application Laboratory fume Hoods	
Perchloric Acid Hoods	5
Radioisotope Hoods	6
Distillation and Floor-Mounted Hoods	6
Not All Enclosures are Laboratory Fume Hoods	
Ductless Carbon-Filtered Enclosures	6
Canopy Hoods	7
Downdraft Hoods	7
Biological Safety Cabinets and Other HEPA-Filtered Enclosures	7
Clean Benches	8
Glove Boxes	8
Laboratory Hood Specifications	
Hood Size	9
Liner Material	9
Sashes	10
Explosion-Proof vs. Non Explosion-Proof Hoods	10
Lighting	10
Service Fixtures	11
Electrical Receptacles	11
Americans with Disabilities Act Requirements	11
Hand-Operated, Positive Energy Control (HOPEC IV)	12
Performance and Installation Considerations	
Face Velocity and Containment Issues	12
Proper Techniques for Hood Use	13
Ventilation System Components and Accessories	
Remote Blowers	13
Blower Sizing	14
Air Volume	14
Static Pressure Loss	14
Integral Motor/Blowers	14
Airflow Monitors	15
Exhaust Air Treatment	15
Ductwork	16
Base Cabinets	16
Work Surfaces	16
By-Pass Blocks	17
Sash Stops	17
Sash Position Alarms	17
Fire Extinguishers	17
Renovating Existing Laboratory Fume Hoods and Ductwork	17
Planning Laboratory Space	
Laboratory Layout	17
Sufficient Room Air	18
Energy Conservation	18
Noise Control	18
Conclusion	18
Laboratory Safety Standards	19
General References	21
Glossary	22

Selecting The Proper Enclosure

What is a Laboratory Fume Hood?

A laboratory fume hood is a ventilated enclosure where harmful or toxic fumes or vapors can be handled safely. The purpose of the hood is to capture, contain and remove contaminants, preventing their escape into the laboratory. This is accomplished by drawing contaminants within the hood's work area away from the operator, so that inhalation and contact are minimized.



Left to right: Protector® Classmate® Laboratory Fume Hood on Protector Storage Cabinets, Protector® Premier™ Laboratory Hood on Protector Storage Cabinet and Protector® XStream™ Laboratory Fume Hood on Protector Storage Cabinets

Airflow into the hood is achieved by an exhaust blower that “pulls” air from the laboratory room into and through the hood and exhaust system. This “pull” at the opening of the hood is measured as face velocity. A baffle, air foil and other aerodynamically designed components control the pattern of air moving into and through the hood. Contaminated air within the hood is then diluted with room air and exhausted through the hood's duct system to the outside where it can be adequately dispersed at an acceptably low concentration.

Laboratory Exhaust Systems and Types of Laboratory Hoods

All laboratory fume hoods' operational airflow can be described as one of two types: conventional and by-pass. Conventional hoods were developed first and have been, for the most part, replaced with by-pass hoods, which have superior performance

features. High performance, reduced air volume and auxiliary-air hoods are variations of the by-pass hood. High performance, auxiliary-air and reduced air volume hoods are variations of the by-pass hood. Hoods use one of two kinds of exhaust systems: constant air volume or variable air volume.

Constant Air Volume (CAV)

Conventional

The conventional hood is a basic enclosure with an interior baffle, movable front sash but no air foil. The conventional hood generally operates at a constant exhaust volume with all of the exhaust air entering the hood through the sash opening. Closing the sash increases the speed of the air through the sash opening so that high face velocities are to be expected with the sash in the nearly closed position (Figure 1).

The conventional hood's performance depends largely on sash position. With the sash in the near closed position, high velocity air passing through the sash opening can damage fragile apparatus, disturb instrumentation, slow distillation rates, cool hot plates, disperse valuable sample materials or result in turbulence inside the hood.

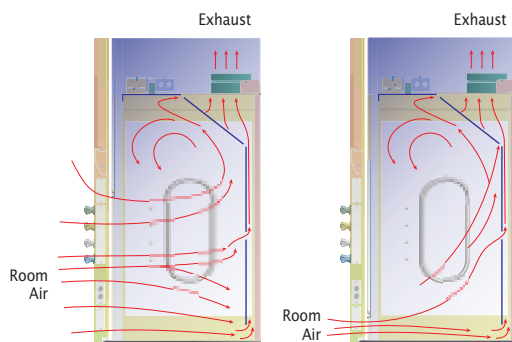

Figure 1. Conventional hood with sash open and nearly closed

By-Pass

The by-pass hood generally operates at a constant volume and is designed so that as the sash is closed, the air entering the hood is redistributed, thereby minimizing the high velocity air streams encountered in conventional hoods. The by-pass openings above the sash and below the air foil reduce fluctuations in face velocity as the sash is raised or lowered (Figure 2). Therefore, the face velocity in by-pass hoods does not generally reach levels that might be detrimental to procedures. By-pass type hoods comprise the majority of hoods in the market.

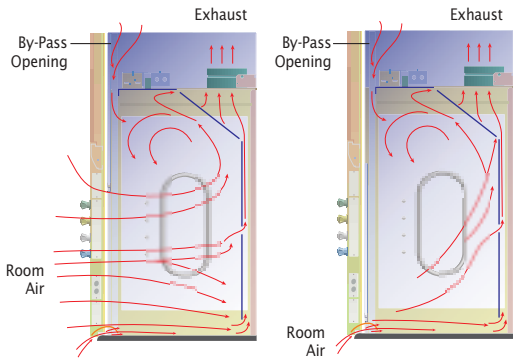

Figure 2. By-pass hood with sash open and closed

High Performance

A variation of the by-pass hood, the high performance hood is the newest generation of fume hoods that rely on containment-enhancing features that maintain safety while saving energy. These design features, which vary by manufacturer, include sash stops or horizontal-sliding sashes to restrict the sash opening; sash position and airflow sensors that control the opening and closing of mechanical rear baffles; small fans to introduce air that operates as a barrier in the operator's breathing zone; or a combination of aerodynamic and anti-turbulence elements such as a dual baffle system with a pattern of variable-sized slots to provide laminar flow through the hood. (Figure 3). Sometimes called "low flow" hoods, these hoods' improved containment allows

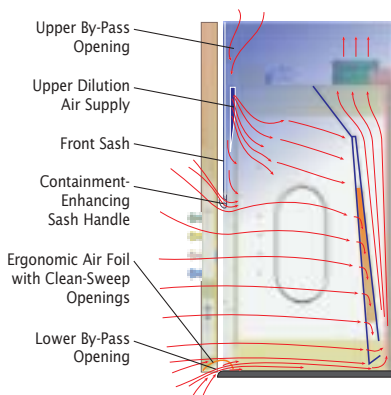

Figure 3. Protector XStream high performance by-pass airflow design

them to operate at face velocities as low as 60 feet per minute (fpm), thus conserving energy and providing an alternative to auxiliary-air hoods in air-starved laboratories, where room supply air is not adequate.

Due to their increased level of sophistication, the initial cost of high performance hoods is slightly higher than traditional by-pass hoods. However, the energy savings realized from operating these hoods

at 60 fpm instead of 100 fpm can average more than \$2000 per year, depending on hood size and sash opening.

Auxiliary-Air

A variation of the by-pass hood, the auxiliary-air hood offers a means of providing up to 50% of the air for the hood exhaust from outside the laboratory, and limits the volume of tempered air removed from

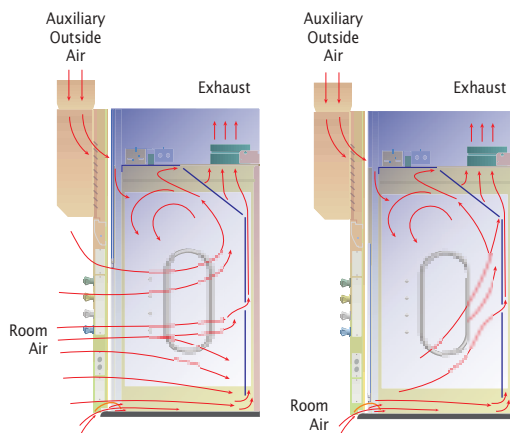

Figure 4. Auxiliary-air hood with sash open and closed

the laboratory (Figure 4). This hood type has many names including induced air, add-air and make-up air.

Auxiliary-air hoods were designed for air-starved laboratories and energy savings. When properly applied, they can provide energy savings by limiting the volume of heated or cooled room air exhausted by the hood. The level of savings depends on the degree to which the auxiliary air must be tempered.

Certain negative aspects of auxiliary-air hoods should be considered. Because two blowers and two duct runs are required, initial equipment and set-up costs are higher than average. Since an oversized auxiliary-air system may overpower the exhaust system, auxiliary-air systems require careful balancing to prevent undesirable turbulence at the face of the hood. In addition, temperature extremes, caused by untempered auxiliary air, can adversely affect the hood's containment ability and cause user discomfort. Finally, the auxiliary air should be clean, dry and tempered properly so it does not interfere with analytical work being done in the hood.

Reduced Air Volume (RAV)

A variation of the by-pass hood, the RAV hood uses a by-pass block to partially obstruct the by-pass opening above the sash to reduce the air volume exhausted thus conserving energy. It is used in

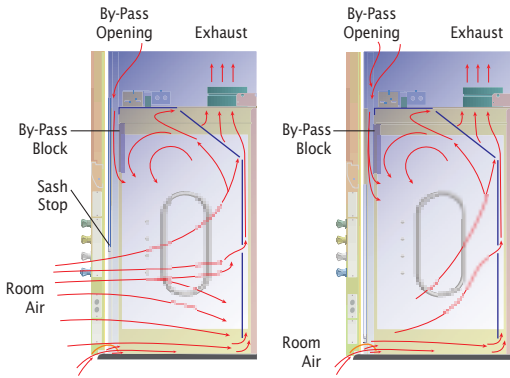

Figure 5. Reduced air volume hood with sash stop and by-pass block shown with sash open to sash stop position and sash closed

conjunction with a sash stop that limits the height the sash may be opened during normal use so that the hood demands less air volume to achieve safe velocity (Figure 5). Since these hoods use less air volume than by-pass hoods of the same size, they require smaller blowers, which can be another cost saving advantage.

RAV hoods should be used with caution. The sash stop should be overridden only when loading or cleaning the hood; never while in use. If the sash stop is disengaged and the sash raised while the hood is in use, the face velocity could drop to an unsafe level. An airflow monitor is recommended.

Variable Air Volume (VAV)

Variable air volume (VAV) hoods vary the amount of room air exhausted while maintaining the face velocity at a preset level. VAV hoods alter the exhaust volume using various methods. One method utilizes a damper that opens and closes based on airflow and sash position. Another method involves varying blower speed to meet air volume demands. When multiple hoods share one common exhaust blower, both methods may be utilized.

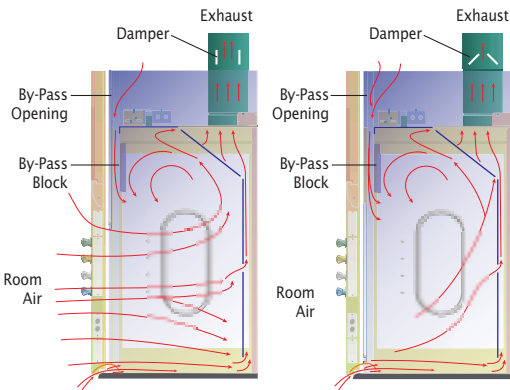

Figure 6. Variable air volume hood with damper control and modified by-pass

Fume hoods with VAV systems generally include a modified by-pass system with by-pass block that ensures that sufficient airflow is maintained to adequately contain and dilute fumes even at low sash positions (Figure 6).

VAV hoods have electronics that allow them to be connected to the laboratory building's heating, ventilation and air conditioning (HVAC) system for monitoring hood exhaust air and controlling laboratory air supply from a central location.

Although initial start up costs may be higher due to building alterations, VAV hoods can offer energy savings over traditional constant volume hoods. At the same time, they offer consistent airflow regardless of sash position. In addition, most VAV systems feature monitors/alarms that alert the operator to unsafe airflow conditions.

Special Application Laboratory Fume Hoods

Some hood exhaust systems accommodate special procedures. Below are descriptions of a few of the many special purpose hoods on the market.

Perchloric Acid Hoods

Perchloric acid hoods are dedicated for use with perchloric acid only. Organic materials should not be used in a perchloric acid hood because an explosion may occur when perchloric acid reacts with organic materials. *Industrial Ventilation: A Manual of Recommended Practice* states that these hoods be constructed of nonreactive, acid resistant and relatively impervious materials such as Type 316 stainless steel, Type 1 unplasticized polyvinyl chloride (PVC) or inorganic ceramic-coated material. Hoods used for these applications have integral work surfaces, radiused interiors, and a drain for easy and thorough cleaning.

Washdown features are required since the hood and duct system must be thoroughly rinsed after each use to prevent the accumulation of

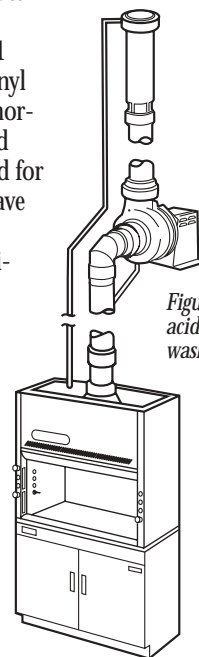

Figure 7. Perchloric acid hood with washdown system

potentially reactive perchloric salts. (Figure 7). Horizontal duct runs and sharp turns should be avoided so that washdown residue drains thoroughly. Each perchloric acid hood requires its own dedicated exhaust system with washdown capability.

Radioisotope Hoods

Hoods used for radioactive applications feature integral work surfaces and radiused interiors to facilitate decontamination. Liner materials, such as Type 304 stainless steel, should be impermeable to radioactive materials. Cupsinks are sometimes provided in the integral work surface, however local codes that dictate the safe disposal of radioactive effluents should be observed. These hoods should be sturdy enough to support lead shielding bricks in instances where they are required. They should also be installed to facilitate the use of high efficiency particulate air (HEPA) or carbon filters in the ductwork. The laboratory's safety officer should determine which, if any, filters are required to trap the radioactive materials emitted during a particular application.

Distillation and Floor-Mounted Hoods

Distillation and floor-mounted hoods are constructed with additional interior height and depth to accommodate large apparatus. Distillation hoods



Protector® XL Floor-Mounted Laboratory Fume Hood

typically mount on a platform instead of a base cabinet or bench. A California hood is a type of distillation hood with sash entry on both sides (Figure 8). Floor-mounted hoods permit roll-in loading of heavy or bulk apparatus. Although formerly known walk-in hoods, the operator should never stand inside a floor-mounted hood while fumes are being generated.

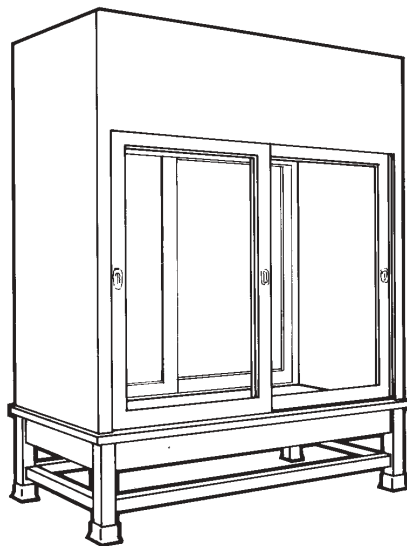

Figure 7. California hood with front and back sashes

Not All Enclosures Are Laboratory Fume Hoods

There are many enclosures designed to protect the operator from exposure to potentially hazardous substances. Other enclosures function to protect the samples contained inside. Although in some instances they may look similar to fume hoods, these containment devices have different modes of operation and different uses.

Ductless Carbon-Filtered Enclosures

As the name implies, ductless enclosures are not connected to an exhaust system. They rely on filters to trap vapors and fumes before air is recirculated to the room. The filters are usually made of specially treated or activated carbon media that treat or adsorb chemical fumes including certain organic solvents, ammonia, acids and formaldehyde. Filter types and capacities can vary widely between manufacturers. Since these enclosures recirculate filtered air back into the laboratory, they often have a built-in mechanism to alert the user to unsafe concentrations of chemicals detected in the exhaust area of the filters.

Filtered enclosures can provide a practical solution for laboratories where ducting may not be feasible. Since they are portable, they may be shared among laboratories and stored out of the way when not in use. Since they do not require ducting, they can be placed on adjustable height base stands and easily lowered for use by wheelchair-bound individuals. Due to the cost of replacing saturated filters, these enclosures are recommended for applications involving only small quantities of chemicals. Since different filters may be required for different chemi-

als, the enclosures are generally restricted to repetitive applications and procedures involving a limited number of chemicals. Carbon-filtered enclosures are not recommended for highly toxic or carcinogenic materials. Careful and regular monitoring by a safety officer is essential to the safe operation of these enclosures.



Protector® 360 Filtered Enclosure on Mobile Base Stand



Canopy Hood

Canopy Hoods

Canopy hoods are designed to remove steam, heat or odors from large or bulky apparatus such as ovens, steam baths or autoclaves. Vapor removal is most efficient when the canopy is mounted no more than 12" above the equipment being ventilated. Because it is inefficient and ineffective in containing fumes, the canopy hood is not recommended for ventilating hazardous substances.

Downdraft Hoods

Like fume hoods, downdraft hoods draw air into the face of the hood. Unlike fume hoods, the blower is usually mounted below the hood work area so that

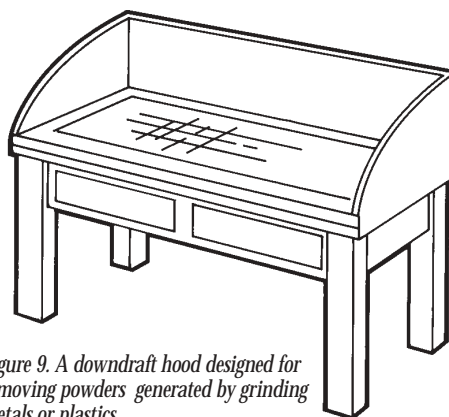

Figure 9. A downdraft hood designed for removing powders generated by grinding metals or plastics

air is pulled down through a mesh work surface and then exhausted to the outside (Figure 9). Downdraft hoods are used for applications involving heavier than air gases and materials such as dusts and powders. In some cases, these materials are recovered for reuse.

Biological Safety Cabinets and Other HEPA-Filtered Enclosures

Although often referred to as "hoods," Class II biological safety cabinets are not fume hoods. Biological safety cabinets are designed to contain hazardous particulates such as bacteria and viruses and often recirculate cabinet air back to the laboratory. Biological safety cabinets use HEPA filters to trap particles while any gaseous materials pass through freely. When exhausted to the outside, they can accommodate trace amounts of toxic chemicals and radionuclides. If the work involves infectious or carcinogenic agents and personnel and product protection are required, then a biological safety cabinet is probably the enclosure of choice. Other HEPA-filtered enclosures, including Class I enclosures that provide only personnel protection, are designed for applications including weighing powders or handling

asbestos. For an in-depth discussion on HEPA-filtered enclosures including Class II safety cabinets and Class I enclosures, request the publication, Personnel and Product Protection: A Guide to Biosafety Enclosures, by calling 800-821-5525 or 816-333-8811 or downloading it from www.labconco.com.



Purifier® Delta® Series Class II, Type A2 Biological Safety Cabinet on Telescoping Base Stand

Clean Benches

Clean benches are devices that use a blower to force room air through a HEPA filter, and over a work surface. This vertical or horizontal laminar flow of fil-



Purifier® Horizontal Clean Bench on Telescoping Base Stand

tered air protects the work from particulate contamination. The major limitation of clean benches is that they provide only product protection; the operator is constantly exposed to any aerosols generated by the work being performed. Consequently, hazardous materials should never be handled in a clean bench. Clean benches were developed as part of “clean room” technology and are widely used in the electronics and pharmaceutical industries. They have also been successfully used in research laboratories for tissue culture and media preparation, and in hospitals and pharmacies for drug preparation.

Glove Boxes

Glove boxes consist of a sealed chamber with glove ports and gloves for handling materials inside, a viewing window for observing, and transfer chamber or door for loading and unloading. Because they provide a physical barrier between the operator and the substances inside, glove boxes are appropriate for applications that require the greatest protection against inhalation of substances used within them. Glove boxes for hazardous materials such as low level radioisotopes and carcinogens filter the chamber air



Protector® Stainless Steel Controlled Atmosphere Glove Box on Mobile Base Stand

prior to exhausting it through a duct system to the outside. Other glove boxes used for containing atmosphere-sensitive materials may or may not be ducted to the outside.

Laboratory Hood Specifications

Hood Size

The working space inside a laboratory hood is defined as that part of the hood interior where apparatus is set up and vapors are generated. This space normally extends from behind the plane of the sash(es) to the face of the baffle, and up from the work surface 34" to 48". The working space required determines the width of the hood needed. OSHA 29 CFR-1910 recommends laboratories provide an average of 2.5 linear feet of hood space per person.

Laboratory hood sizes are commonly expressed

by the outside width and not by working space. The most common hood widths are 3, 4, 5, 6 and 8 feet. Custom designed fume hoods may have widths up to 24 feet. The actual working space is approximately 5" to 12" less than the expressed exterior width of the hood.

Liner Material

The liner material selected should be durable and resist chemicals, heat and open flame. A description of common liner materials and their characteristics is shown (Table 1). The best liner material for a hood should be determined by the applications, types and

Table 1. Common Liner Materials and Their Characteristics

Liner Material	Stain Resistance	Moisture Resistance	Chemical Resistance	Heat Resistance	Flame Spread Index*	Other Comments
Epoxy-coated steel	Good	Very good	Good	Very good	≤5	Care must be taken to avoid damaging coating since corrosion may occur in damaged areas. Inexpensive.
Epoxy resin	Good	Excellent	Excellent	Very good	**	Not easily modified. Brittle, requires care in handling. Expensive.
Molded Fiberglass reinforced polyester (FRP)	Good	Excellent	Excellent	Very good	≤25	Excellent light reflective properties. Moldable to eliminate seams and crevices. Easily modified. Moderately expensive.
Fiberglass reinforced composite panel	Good	Excellent	Excellent	Very good	≤25	Good sound-dampening qualities. Heavy. Inexpensive. Easily modified.
Glass reinforced cement (GRC)	Fair	Fair	Very good	Excellent	0	Good sound-dampening qualities. Heavy. Inexpensive. Easily modified.
Poly-propylene	Very good	Excellent	Excellent	Poor	**	Easily modified. Expensive.
Polyvinyl chloride (PVC)	Very good	Excellent	Excellent except for some solvents	Poor. Will distort at 160° F	≤20	Easily modified. Well-suited for sulfuric and hydrofluoric acid digestions. Expensive.
Phenolic composite panel	Good	Excellent	Excellent	Very good	≤25	Excellent light reflective properties. Well-suited for corrosive materials. Moderately expensive.
Stainless steel (Type 316 or 304)	Good	Excellent	Good resistance to a wide range, subject to attack by some acids	Excellent	0	Primarily used for special applications involving perchloric acid or radioisotopes. Heavy. Difficult to modify. Expensive.
Tempered Safety Glass	Excellent	Excellent	Excellent	Very good	0	Good for teaching demonstrations. Cannot be field modified. Requires frequent cleaning to maintain transparency. Heavy. Expensive.

* The lower a material's flame spread index, the greater its flame-retarding capabilities. The index varies with the thickness of materials and other factors. NFPA 45 Standard on Fire Protection for Laboratories Using Chemicals states that materials of construction should have flame spreads of 25 or less. The flame spread index is determined using ASTM E84 test method, which compares the surface flame spread and smoke development measurements of a particular material to those obtained from tests of standard calibration materials at the opposite ends of the spectrum - mineral fiber cement board (flame spread index = 0) and select grade red oak flooring (smoke spread index = 100). The test specimen surface, 18" wide x 24" long, is exposed to a flaming fire for 10 minutes. Flame spread over its surface is measured and recorded. Test results are presented as the computed comparisons to the standard calibration materials.

** Contact manufacturer

concentrations of chemicals that will be handled in the hood and exhaust system. Laboratory hood effluents may be classified generically as organic or inorganic chemical gases, vapors, fumes or smoke — and qualitatively as fume acids, alkalis, solvents or oils. Hood liners are subject to attack from such effluents by: (1) corrosion (the destruction of metal or other material by chemical or electrochemical action), (2) dissolution (a dissolving action to which coatings and plastics are subject), and (3) melting (occurs with certain plastics and coatings at elevated operating temperatures). The effect of any decontamination materials on the hood liner should also be considered.

Working temperatures inside the work space also affect the selection of liner materials. Certain codes and insurance underwriters have flame and smoke spread rating requirements that establish prescribed limits to applicable materials. Most local environmental authorities have codes that incorporate standards based on National Fire Protection Association (NFPA) Standard No. 45, Fire Protection for Laboratories Using Chemicals.

Sashes

Sashes provide some physical protection from splashes and reactions, and are transparent to allow viewing. Sashes rise vertically, slide horizontally or combine both horizontal and vertical characteristics in a design known as a combination “A-style” sash (Figures 10, 11 and 12). Sash configuration selection is a matter of preference. Vertical rising sashes are the most popular and allow large apparatus to be loaded in the hood. Horizontal sliding sashes allow the operator to reach around both sides of the sash while using the sash as a shield. Because the sash opening is smaller, they conserve energy by limiting the volume of air exhausted.

Tempered safety glass is the most common and economical choice for sash material. Polycarbonate sashes are recommended when hydrofluoric (HF) acid is used since this material does not fog or etch when exposed to HF fumes.

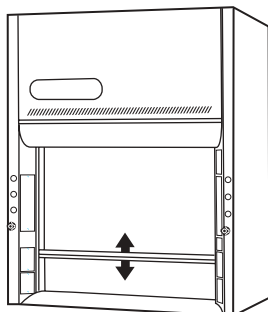

Figure 10. Hood with vertical-rising sash

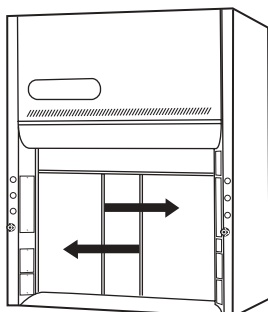

Figure 11. Hood with horizontal-sliding sashes

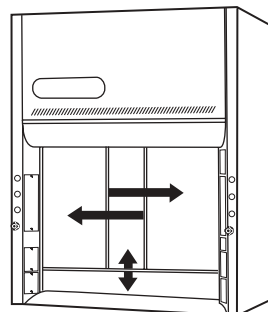

Figure 12. Hood with combination “A-style” sash

Explosion-Proof vs. Non Explosion-Proof Hoods

An explosion-proof hood may be required for protection when specific concentrations of flammable or explosive materials are to be used. An explosion-proof hood is defined by most manufacturers as a laboratory hood equipped with specially designed electrical components, such as explosion-proof light fixtures. Explosion-proof does not mean that the hood is capable of containing or withstanding an explosion. Rather it means that electrical components are designed to eliminate sparks and prevent the escape of flame or heat that could ignite flammable materials. An explosion-proof hood’s electrical components, such as explosion-proof switches, receptacles and internal wiring, are supplied and installed on site by a licensed electrician in order to meet all state and local codes. In addition to the components on the hood, the electrical apparatus used inside the hood should also be explosion-proof by design. The National Electrical Code can provide details about specific explosion-proof components.

Lighting

Light fixtures come in either vapor-proof or explosion-proof styles (Figure 13). Vapor-proof light fixtures are usually fluorescent, installed outside the hood liner and protected from the hood interior by a

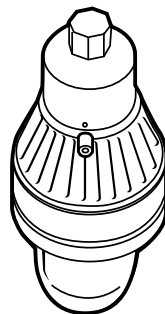

Figure 13. Explosion-proof light fixture protects incandescent bulb with globe and sealed housing

transparent, impact-resistant glass shield. Access for replacing or cleaning should be from the exterior, whenever possible. Explosion-proof lights are normally incandescent bulbs protected by a specially reinforced fixture mounted in the hood.

Service Fixtures

Utility services include connections to gases, air, water and vacuum (Figure 14). If service fixtures are required, they should be installed to allow the connection of service supply lines either on the hood itself or the work surface supporting the hood. All

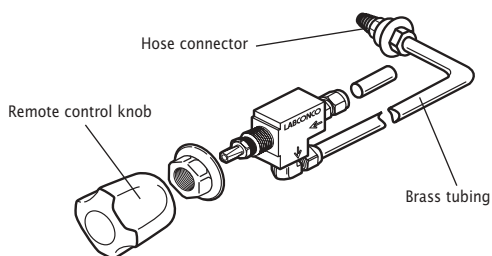

Figure 14. Components of a gas service fixture

service valves should be accessible for maintenance and should be corrosion resistant if located inside the hood. The plumbing tubing should be of the proper material to satisfy local code requirements. For example, some states require gas service connections to be made with black iron pipe or brass tubing. For safety and convenience, all service fixtures should be remotely controlled from outside the hood and clearly identified.

Electrical Receptacles

If electrical receptacles are required, they are usually located on the hood exterior, away from the corrosive effects of the fumes inside the hood structure (Figure 15). Provisions should be made so that all electrical wiring is isolated and physically separated from vapors handled within the hood.

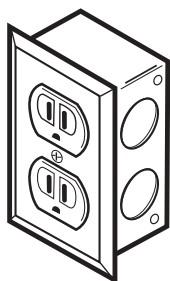

Figure 15. Duplex electrical receptacle

Americans with Disabilities Act Requirements

Employers, except very small businesses, must comply with the Americans with Disabilities Act (ADA), the federal law that went into effect on January 26, 1992, prohibiting discrimination against disabled individuals in employment. Fume hoods and acces-



Protector® XL Laboratory Fume Hood on Manual Hydraulic Lift Base Stand may be lowered to accommodate wheelchair-bound users. Hoods on adjustable base stands require special modifications to incorporate flexible ducting, wiring and plumbing

sories are available with features that meet the requirements of the ADA. Switches, controls and written instructions should be located where they can be seen and reached by a seated person. ADA Standards for Accessible Design specifies that forward reach should be a maximum of 48 inches high and side reach a maximum of 54 inches high. To allow a person in a wheelchair to work comfortably, ADA also specifies that work surface height should be from 28 to 34 inches above the floor and knee clearance underneath should be at least 27" high, 30" wide and 19" deep. Audible alarms must have an intensity and frequency that can attract the attention of individuals who have partial hearing loss. The ADA Standard states that audible emergency alarms shall produce a sound that exceeds the prevailing equivalent sound level in the room or space by at least 15 dB or exceeds any maximum sound level with a duration of 60 seconds by 5 dB, whichever is louder.

Hand-Operated, Positive Energy Control (HOPEC IV)

HOPEC IV is a hood design developed by a laboratory planner in response to the ADA, OSHA laboratory standard and other ergonomic concerns. The HOPEC IV hood is suitable for use by wheelchair-bound users as well as non-disabled users. The sash viewing area is taller than traditional benchtop hoods, which permits mounting the hood in either a high or low position while maintaining usable access. The air foil, which may be an obstacle to users of traditional hoods, includes a spill trough.



Protector® XL HOPEC IV Laboratory Fume Hood on ADA-compliant Protector® Standard Storage Cabinets

For energy efficiency, the sash is a combination horizontal/vertical-rising to reduce airflow requirements and sash stops limit the sash opening height to 50%. The sash stop in combination with a by-pass block reduce the total amount of air exhausted from the hood. To further limit the sash opening, the upper 6" of the sash is stationary so that energy conservation does not compromise visual accessibility.

Safety features include a digital airflow monitor to alert the user to low velocity conditions, a sash pocket to prevent laboratory exposure to contaminated interior sash surfaces as the sash is raised, a highly-visible yellow air foil with integral trough to contain spills, and an interior depth of approximately 30 inches to allow fume-generating materials to be placed deep within the hood while still allowing adequate room for procedures.

Performance and Installation Considerations

Face Velocity and Containment Issues

The laboratory's degree of exposure to toxic contaminants is an important consideration when selecting a fume hood. The concentration of contaminants in the actual breathing zone of the operator should be kept as low as possible. Two fume hood issues that impact the concentration of contaminants are face velocity and containment.

Regulatory compliance agencies and other advisory groups have established guidelines relating to the exposure limits of various chemical reagents. These exposure limits are identified as American Conference of Governmental Industrial Hygienists (ACGIH) Threshold Limit Values (TLV) or Occupational Safety and Health Administration (OSHA) Permissible Exposure Limits (PEL). Threshold Limit Values refer to airborne concentrations of substances and represent conditions under which it is believed workers may be repeatedly exposed day after day without adverse effect.

Until recently, general thinking was that the lower the TLV number, the higher the face velocity required to ensure adequate protection for the operator. Face velocity is still regarded as an important parameter for assessing a hood's performance. However, present views focus on containment rather than face velocity alone. The emergence of high performance hoods is evidence of this trend. Higher velocity is not necessarily better. A face velocity that is too high can cause turbulence within the hood and actually decrease the hood's ability to contain contaminants. Refer to Laboratory Ventilation Standards on page 19.

Factors that affect the performance level of the laboratory hood that are not easily monitored by simple measurement of face velocity include: 1) type and location of air supply; 2) location of laboratory hood in relationship to the laboratory itself; 3) air disturbances caused by overhead air diffusers, heat registers, fans, open windows or doors, or personnel movement; 4) hood sash configurations; 5) location of the worker in relation to the hood; 6) location and types of emission sources; 7) apparatus loaded or stored in the hood; 8) use of apparatus such as machine tools, grinders or centrifuges that generate aerosols and/or high velocity particles; and 9) thermal drafts due to extreme temperature conditions.

Because of these external demands, the American Society of Heating, Refrigerating and Air-Conditioning Engineers (ASHRAE) Standard 110-95 was developed to demonstrate the laboratory hood's ability to contain and exhaust contaminants released inside the hood.

ASHRAE Standard 110-95 is a performance test, not a performance specification. It describes how to evaluate a hood's performance, but it does not specify the performance level required. It remains the responsibility of the user, industrial hygienist, safety officer or applications engineer to specify the performance level requirement for a laboratory's individual situations.

ASHRAE Standard 110-95 gives a relative and quantitative determination of the efficiency of the hood to capture contaminants under a set of strict conditions. This test is used to evaluate hoods, both in the manufacturer's facility (as manufactured, AM), and on site (as installed, AI, or as used, AU). Briefly, ASHRAE Standard 110-95 is a three-part test. First, the average face velocity is calculated. The sash opening is divided into one-foot squares. Velocity readings are taken in each grid area and averaged.

Second, the hood is tested for its ability to contain fumes. Titanium tetrachloride, which emits a white smoke, is released at prescribed locations within the hood's interior and work surface. Smoke is observed and any air movement toward the face of the hood and any areas of no air movement are noted. Titanium tetrachloride is also passed under the air foil and any smoke flowing out the front is noted.

In the final part of the test, a tracer gas is released at an established rate and at various positions within the hood. The gas is monitored in the breathing zone of a mannequin placed at various positions in front of the hood. Based on the average exposure in the breathing zone, a performance rating is determined. The complete standard is available from ASHRAE.

It is recommended that laboratory hoods be tested at the time of installation to verify the AM test results. Initial testing provides a baseline for future maintenance checks. Hood performance should be monitored and maintained as part of the laboratory's chemical hygiene plan.

Proper Techniques for Hood Use

Containment and efficient removal of fumes are enhanced when the operator follows proper hood procedures. Apparatus should be placed at least six inches inside the hood. Large apparatus that can obstruct airflow should be elevated on blocks to allow fumes to pass under them. The hood should not be used as a storage cabinet; equipment in the hood should be kept to a minimum so airflow is not compromised. Finally, the sash should be closed as much as possible when work is being performed inside the hood. The Industrial Ventilation Manual may be referenced for a complete list of recommendations for proper operator techniques.

Ventilation System Components and Accessories

The laboratory hood is just one component of a complete fume ventilation system. At the same time a hood is selected, a blower, ductwork, base cabinet and work surface must also be selected (Figure 16). Air supply must be determined as well. A laboratory fume hood may, as appropriate, also include an air-flow monitor, filtration system and fire extinguisher.

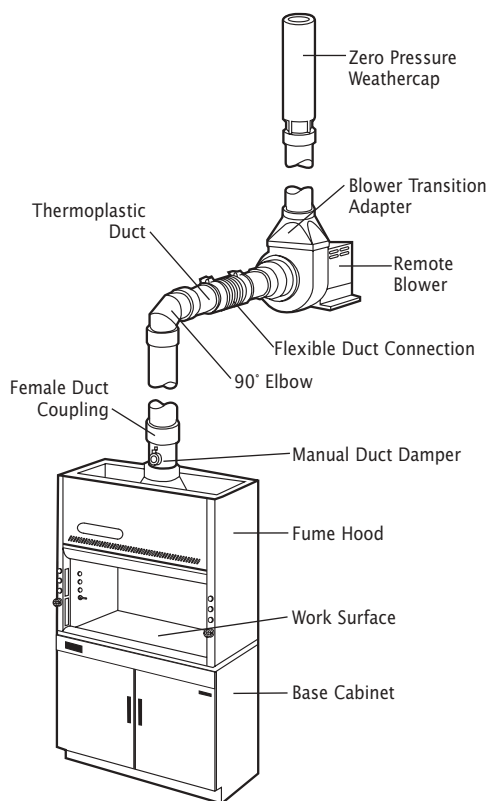

Figure 16. Typical components of a hood ventilation system

Remote Blowers

Of all the additional components needed, the blower is the most crucial to the performance of the hood. Fume hood installations utilizing remote blowers are the most common type. Since the entire duct length is under negative air pressure, any leakage in the duct is drawn in and contained rather than pushed out into the building environment. The exhaust blower is positioned in a penthouse or on the building's exterior, usually on the roof, where noise is less noticeable. By creating suction within the ductwork, blowers draw air from the laboratory room, through the hood and out the duct system.

Centrifugal type blowers are popular because they are more efficient and less noisy than others. Belt-driven impellers have greater flexibility than

direct-drive impellers because the sheaves can be adjusted to vary the air volume. Blower components are constructed from a variety of materials. To resist corrosion from chemical fumes, impellers and housings may be made of various types of metal, fiberglass or plastic. For weather-proofing when roof-mounted, blowers have protective housings. Blowers used to exhaust potentially flammable materials should be explosion-proof, meaning that they are designed to prevent generation of a spark.



Labconco Fiberglass Blower, a centrifugal blower with belt-driven impeller

In addition to centrifugal blowers, other exhaust devices are available including air ejectors (Figure 17). An air ejector creates suction by venturi method to draw fumes through the ductwork. Air ejectors are suitable for use with highly corrosive fumes, such as perchloric acid, because the blower wheel never comes into contact with the fumes. Air ejectors are considerably more expensive and noisier than centrifugal type blowers.

Blower Sizing

To provide the optimum face velocity and air volume for the laboratory hood, the blower must be sized properly. Although horsepower and revolutions per minute (RPM) are important blower specifications, blower selection should be based on the air volume the hood will exhaust and the total static pressure loss of the entire system.

Air Volume

The air volume passing through the hood is generally equal to the area of the sash opening multiplied by the average velocity desired. For example, if 100 feet per minute (fpm) is required and the hood has a sash opening of 7.5 square feet, then the hood's air volume is 750 (7.5 x 100) cubic feet per minute (CFM).

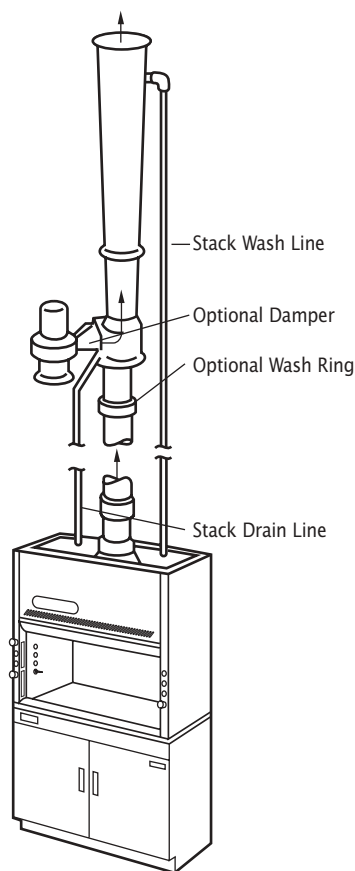

Figure 17. Air ejector installed with washdown system

Static Pressure Loss

At any given exhaust volume, the hood has a unique static pressure loss usually expressed in inches of water. The manufacturer can provide this static pressure loss information. In addition, the ductwork components (duct, elbows, reducers, weathercaps) and filters in the system have static pressure losses based on the volume of air passing through them, which is often expressed as equivalent resistance in feet of straight duct. To determine the total pressure loss in the ductwork, the equivalent resistance in feet of straight duct for all the components in the system is totaled. This total equivalent feet provides a method to calculate the static pressure loss at specific air volumes. The static pressure loss of the ductwork is added to the static pressure losses of the hood and any filters for the total static pressure loss of the system.

Integral Motor/Blowers

Some fume hoods are available with blowers built directly into the hood superstructure (Figure 18). These hoods are relatively easy and inexpensive to install. However, a built-in blower should not be used for corrosive or highly toxic applications since it

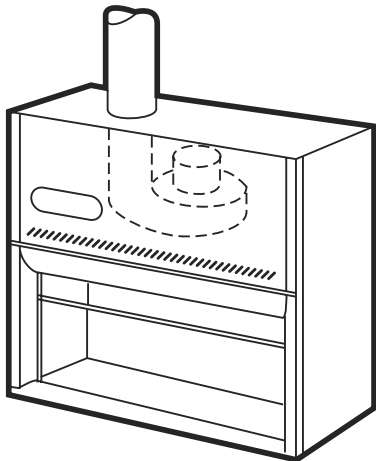

Figure 18. Hood with integral motor/blower

causes positive air pressure in the duct system, and any leaks could push contaminants out of the ductwork. This type of hood may be noisier since the blower is closer to the user. Long duct runs, too, may prohibit its use since these blowers are sized to fit a narrow range of static pressure requirements. The manufacturer can provide duct length parameters for its laboratory hoods with built-in blowers.

Airflow Monitors

American National Standards Institute (ANSI) Standard Z9.5 recommends the use of an airflow monitor, a device that gives warning (by a visible or audible signal, or both) when the airflow through the hood has deviated from a predetermined level. When mounted in an easily accessible area, monitors may have locking devices to prevent tampering by unauthorized personnel. Other monitors include a remote



Guardian™ Digital Airflow Monitor

alarm signal and/or automatic auxiliary-air/exhaust blower interlock that shuts off the auxiliary-air blower should the exhaust blower fail.

Exhaust Air Treatment

Depending on the hazard level associated with the laboratory operation, and the degree of pollution abatement required, treatment for the hood's effluents may be necessary. Treatment methods include filtering, wet scrubbing and incineration, each effective for a specific range of materials. No universal treatment exists.



Figure 19. HEPA filter with housing designed for in-line connection to duct system

Dry media filters (95% efficient by ASHRAE Standard 52-68 Test Method) or HEPA filters (99.97% efficient by DOP Test Method) may be required to meet specified design criteria (Figure 19). The filter assembly may include a prefilter for capturing coarse particles and a filter enclosure arranged for easy access. For removing gaseous organic compounds, activated carbon filters are often satisfactory. Many filters are not suitable for collecting radioisotopes. Consult a reputable filter manufacturer for specific recommendations.

For convenient handling, replacement and disposal with minimum hazard to personnel, the filter should be: (1) located outside the laboratory area unless it is an integral part of the hood; (2) before the remote exhaust blower; and (3) installed in space that provides free, unobstructed access. The filter should be located on the suction side of the exhaust blower and as close to the laboratory as possible to minimize the length of contaminated ductwork. Some installations will require shut-off dampers and hardware for filter decontamination in the ductwork. A damper is often added to filtered hoods to balance airflow because HEPA filters vary and change in airflow resistance as they load during use.

The filter housing should provide for easy transfer of the contaminated filter to a disposal site. Depending on the nature of the work, the filter may

need to be treated as hazardous waste. Local codes should be consulted for regulations on disposal.

Fume scrubbers are another type of device placed in the hood or in the fume duct system to remove particulates and soluble contaminants from exhaust air. Scrubbers use water or chemical sprays to remove particulates and to neutralize and dilute acids or alkaline materials (Figure 20). Scrubbers may have a filtering system to trap particulates.

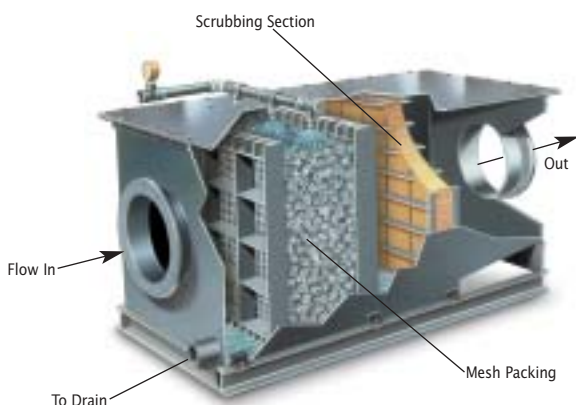

Figure 20. Swirlaway® Fume Scrubber utilizing water spray

Ductwork

Ductwork includes fume pipe, male and female couplings, elbows, reducers and exhaust discharge stacks (weathercaps). Round diameter duct made of rigid materials offers the least static resistance. Like the liner material of a laboratory hood, duct material must be resistant to the fumes exhausted through it. Ductwork made of unplasticized polyvinyl chloride (PVC) is a popular choice because it is rigid, highly resistant to both acid and solvent vapors and, because it is extruded, comes in round diameters.



Round PVC pipe with female coupling



90-Degree PVC elbow

Stainless steel and coated steel are used when very high temperatures are anticipated and because they offer fire protection. Fiberglass provides high structural strength and corrosion resistance. Local codes should be consulted for duct material recommendations.

Base Cabinets

Most laboratory hoods are designed to rest on a bench-high base stand or cabinet with a work surface. Existing casework may be used as long as it provides adequate depth and height for the structural support of the hood. Base stands that allow the users to be in the sitting position may be preferable for



Protector® Solvent Storage Cabinet

persons with limited mobility. Specialty base cabinets are available that store acids, solvents, vacuum pumps or supplies. If base cabinets are vented into a laboratory hood, they will be ventilated only if the hood is operating continuously. Chemical storage cabinets that need ventilation can be more effectively and economically ventilated with a separate, continuously running exhaust system than by connecting them to a laboratory hood.

Work Surfaces

The work surface, the slab or platform that supports the hood, should be made of a chemical-resistant and heat-resistant material compatible with the application. Most are



SpillStopper™ Work Surface

designed with a dished surface to contain spills. Popular choices include molded epoxy resins, aluminum silicate, natural stone and other compos-

ite materials. Specialty hoods, such as those for perchloric acid and radioisotope applications, have built-in work surfaces. The smooth one-piece design of built-in work surfaces improves and simplifies decontamination procedures. Built-in work surfaces require a structural support underneath them.

By-Pass Blocks

As described earlier, by-pass hoods are designed so that as the sash is closed, the constant volume of air entering the hood is redistributed to by-pass openings, which helps reduce the potential for extremely high face velocities. By-pass blocks partially obstruct the by-pass openings above the sash of the hood to reduce the air volume demanded. When used with a sash stop, a by-pass block can conserve conditioned room air and maintain face velocity.

Sash Stops

A sash stop is a device to restrict the sash opening height during normal working conditions. Maintaining the sash in a lowered position can

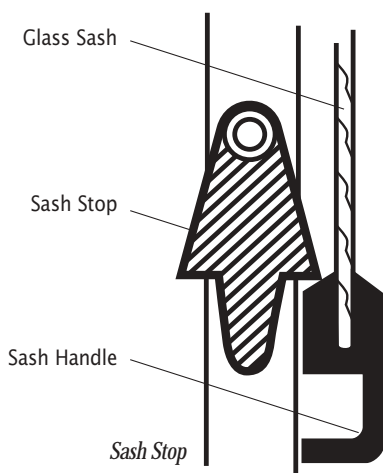

reduce the exhaust volume demand so hoods with sash stops may utilize small blowers. This practice generally requires a by-pass block.

Sash Position Alarms

To encourage users to keep the sash lowered, a sash position alarm provides audible and/or visual warning when the sash is raised above a designated level. Sash position alarms may be used alone or in conjunction with a sash stop.

Fire Extinguishers

Hoods can be scenes of fires due to the nature of some experiments. Some hood manufacturers offer automatic fire extinguishers that mount inside or

adjacent to the hood and discharge at pre-determined temperature set points, providing around-the-clock protection.

Renovating Existing Laboratory Fume Hoods and Ductwork

While the changes may be subtle to the untrained eye, modern laboratory fume hoods are much more efficient at capturing fumes than earlier models. Hoods can now be tested according to ASHRAE 110-95 and their performance levels compared to others. The addition of air foils at the front lip of the bench and other aerodynamic components have reduced turbulence and loss of containment from the hood.

It is usually not possible to retrofit older hoods to bring their performance up to today's standards. The addition of necessary components to an older hood is an expensive custom exercise that requires exacting engineering and design knowledge.

When replacing or adding to existing ductwork, extreme caution is required to avoid exposure to contaminants. In particular, ductwork exposed to perchloric acid can be potentially explosive and should only be removed by personnel experienced in handling these substances. Anytime an exhaust system is modified, testing should be done to ensure that the changes have not affected fume hood performance.

Planning Laboratory Space

Whether adding one hood to an existing laboratory or installing hundreds in a new facility, planning is crucial. Because each hood affects the room's ventilation and traffic flow, the whole picture must be considered including the laboratory space, the building's ventilation and the hood's location in the room. The first and most imperative step taken should be to consult a qualified laboratory ventilation expert who can provide helpful advice through the planning, selection and installation phases.

Laboratory Layout

In determining the amount of space necessary for the laboratory, a layout of all essential laboratory equipment should be made. The hood should always be located so that exit from the laboratory will not be impeded in the event of a fire or explosion within the hood structure itself. The hood should also be located away from high pedestrian traffic lanes in the laboratory to avoid disruptions to the airflow entering the hood. Cross currents from room ventilation should also be avoided, as they distort the flow of air essential to the safe operation of the fume hood. If ventilation components are in place, an attempt should be made to position the hood out of their

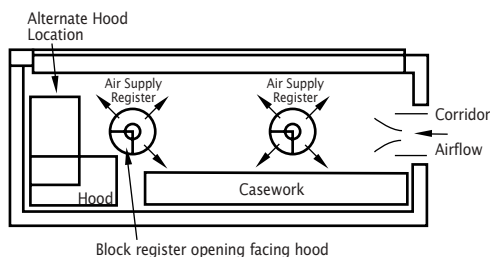

Figure 21. Laboratory layout showing hood located away from exits and potential airflow disruptions

influence (Figure 21). Some redirecting or blocking may be necessary. Hoods should not be installed in a location where it is likely to be affected by another piece of equipment, such as a biological safety cabinet or another fume hood. If possible, the hood side wall should be at least one foot away from the room wall to allow access to service connections.

Sufficient Room Air

A fume hood should not be installed without first considering whether the laboratory's supply air system will be able to replace all of the air exhausted. For proper hood operation and user safety, there must be sufficient room air available for exhausting to achieve the face velocity required. The National Fire Prevention Association (NFPA) Code 45 calls for replacing the laboratory with slightly less than the amount of air exhausted from the hood. This negative pressurization causes a slight inflow of air into the laboratory from corridors and non-laboratory spaces that helps to keep contaminants from spreading throughout the building.

In general laboratory situations, "Prudent Practices for Handling Hazardous Chemicals in Laboratories" states that the room air should be totally replaced at least 4-12 times an hour. Special laboratory functions may require an even greater number of air exchanges to ensure personnel safety. Open windows are not a substitute for a properly designed make-up air system.

"Air changes per hour" or "air changes per minute," however, are not a basis for ventilation criteria when environmental control of hazards, heat and/or odors is required. The required ventilation depends on the problem, not on the size of the room in which it occurs. The laboratory's safety officer should establish design criteria for room air changes.

Energy Conservation

For every 300 cubic feet per minute of air exhausted, approximately one ton of refrigeration is required. With energy resources becoming scarcer and more

expensive every day, conservation is a high priority. Several methods to reduce the energy consumed by a hood have been developed.

High performance hoods may be safely operated at lower face velocities, and thus lower air volumes, to conserve energy. Variable air volume hoods use dampers or variable speed blowers to decrease the volume of air exhausted when demand is low, such as at night. Reduced air volume hoods function with by-pass blocks and sash stops that reduce the maximum sash opening areas thus lessening the air volume requirements. Auxiliary-air hoods can reduce the hoods' demand for room air by replacing a portion of the conditioned air exhausted with supplemental air from outside the laboratory. Proper user training can enhance energy conservation as well.

Noise Control

According to OSHA Standard 29 CFR Part 1910.95, the action level for providing personal protection against the effects of noise exposure is an average of 85 decibels or greater during an 8 hour workday. Following certain guidelines ensures that the noise in the laboratory created by a laboratory hood ventilation system never approaches the permissible noise level. The hood should be aerodynamically designed to reduce the noise created by air passing through it. Properly sized duct components installed with the minimum number of elbows reduces air movement noise. Installing the blower outside the laboratory, preferably on the roof, keeps the single largest source of noise away from the workplace. Sturdily constructed hoods and vibration-isolating components such as flexible duct connections minimize vibration noise.

Conclusion

The purpose of the preceding discussion was to present important factors to consider when selecting a laboratory fume hood ventilation system. Space limitations kept discussions brief. The General References that follow offer sources of in depth information on the factors presented in this booklet. Labconco can also provide technical assistance and help with laboratory planning. Our sales engineers and product specialists combine their expertise to help solve end users' laboratory ventilation problems. You can reach us at 800-821-5525, 816-333-8811 or labconco@labconco.com.

Laboratory Safety Standards

Federal Register 29 CFR Part 1910.1450

National Research Council Recommendations Concerning Chemical Hygiene in Laboratories (Non-mandatory) from "Prudent Practices."

- Fume hoods should have a continuous monitoring device.
- Face velocities should be between 60-100 linear feet per minute (lfpm).
- Average 2.5 linear feet of hood space per person.

Federal Register 29 CFR Part 1910.95

Occupational noise exposure

- Protection against exposure to noise must be provided when average noise levels are at or above 85 dB during an 8-hour workday.

Occupational Safety & Health Administration

U.S. Department of Labor

200 Constitution Avenue, NW

Washington, DC 20210

(800) 321-6742

www.osha.gov

Industrial Ventilation-ACGIH

- Fume hood face velocities between 60-100 lfpm.
- Maximum of 125 lfpm for radioisotope hoods.
- Duct velocities of 1000-2000 fpm for vapors, gases and smoke.
- Stack discharge height 1.3-2.0 x building height.
- Well designed fume hood containment loss <0.10 ppm.

Industrial Ventilation:

A Manual of Recommended Practice

23rd Edition, 1998

American Conference of Governmental Industrial Hygienists

1330 Kemper Meadow Drive

Cincinnati, OH 45240

(513) 742-2020

www.acgih.org

ASHRAE 110-1995 Method of Testing Performance of Laboratory Fume Hoods (ANSI Approved)

Evaluates fume hood's containment characteristics

- Three part test: Smoke generation, face velocity profile, tracer gas release @ 4 liters per minute.
- Rated As Manufactured (AM), As Installed (AI) and As Used (AU).

American Society of Heating, Refrigerating and Air-Conditioning Engineers

1791 Tullie Circle NE

Atlanta, GA 30329

(404) 636-8400

www.ashrae.org

ANSI Z9.5-1993 Standard-Laboratory Ventilation

Covers entire laboratory ventilation system.

- Vertical stack discharge @ 2000-3000 fpm.
- New and remodeled hoods shall have a monitoring device.
- Ductless hoods should only be used with non-hazardous materials.

American Industrial Hygiene Association

2700 Prosperity Avenue, Suite 250

Fairfax, VA 22031

(703) 849-8888

www.aiha.org

SEFA 1-2002 Laboratory Fume Hoods

Recommended Practices

- Fume hood face velocities based on toxicity levels of chemicals.

Class A – materials of extreme toxicity – 125 to 150 fpm.

Class B – standard lab chemicals – 80 to 100 fpm.

Class C – materials of low toxicity – 75 to 80 fpm.

- Test method – face velocity profile and smoke generation.

Scientific Equipment & Furniture Association

1205 Franklin Avenue

Suite 320

Garden City, NY 11530

(516) 294-5424

www.sefalabs.com

NFPA 45: Standard on Fire Protection for Laboratories Using Chemicals, 2000 Edition

- Laboratory hoods should not be relied on for explosion protection.
- Fume hood exhaust air should not be recirculated.
- Services should be external to the hood.
- Canopy hoods only for non-hazardous applications.
- Materials of construction should have flame spread of 25 or less.
- Minimum volume of 25 CFM per square foot of fume hood's internal work space is recommended.

National Fire Protection Association

1 Batterymarch Park

P.O. Box 9101

Quincy, MA 02269-9101

(800) 344-3555

www.nfpa.org

ASTM E84-01 Standard Test Method for Surface Burning Characteristics of Building Materials

Determines the relative burning behavior of the material by observing the flame spread along the specimen.

- Measures flame spread and smoke development.
- Material is exposed to flaming fire for 10 minutes and the results measured and recorded.
- Results are compared to the indexes of mineral fiber cement board (flame spread and smoke development of zero) and red oak flooring (smoke development of 100).

ASTM International
100 Barr Harbor Drive
P.O. Box C700
West Conshohocken, PA 19428-2959
(610) 832-9585
www.astm.org

UL 1805-Standard for Laboratory Hoods and Cabinets

- Hood interior constructed of nonflammable, corrosion and chemical-resistant materials.
- Counterbalanced sash of non-shattering material.
- Shielded by-pass opening.
- Dished work surface to contain spills.
- No air recirculation.
- Integral blower wheel of nonsparking materials.
- Externally mounted electrical receptacles, light fixtures and service fixture controls.
- No indication of reverse flow or backflow when tested with sash at full, 2/3 and 1/3 open positions at flow rate recommended by the manufacturer.

UL 61010-1 (formerly 3101-1) Electrical Equipment for Laboratory Use

Specifies the general safety requirements for electrical equipment.

- Based on International Electrotechnical Commission (IEC) Publication 61010-1 with differences noted for U.S. use.
- Tests for protection against electrical shock, mechanical hazards, spread of fire, radiation, liberated gases, explosion and implosion.
- Tests for resistance to shock, vibration, impact, heat, moisture and liquids.

Underwriters Laboratories Inc.
333 Pfingsten Road
Northbrook, IL 60062
(847) 272-8800
www.ul.com

CAN/CSA Standard C22.2 No. 1010.1-92 Safety Requirements for Electrical Equipment for Measurement, Control and Laboratory Use

Specifies general safety requirements for electrical equipment

- Design and methods of construction should provide adequate protection to the operator and the surrounding area against shock or burn, mechanical hazards, excessive temperature, spread of fire from the equipment, gas liberation, explosion or implosion.

Canadian Standards Association
5060 Spectrum Way
Mississauga, Ontario
L4W 5N6
CANADA
(800) 463-6727
www.csa.ca

CE Marking

Established in 1993 to standardize the European Community's electrical directives into a single set of regulations. Indicates an electrical apparatus conforms to all safety and other directives/specifications presently required by the Council of European Communities.

- Electrical safety.
- Electromagnetic emissions testing — interference signals being output by the product.
- Electromagnetic immunity testing — the product does not respond to outside electromagnetic interference signals.

European Union
www.europa.eu.int
European Union
Delegation of the European Commission to the United States
2300 M Street, NW
Washington, DC 20037
(202) 862-9500
www.eurunion.org

ADA Standards for Accessible Design

Federal law revised in 1994 that prohibits discrimination based on disability by public accommodations and in commercial facilities.

- Forward reach should be a maximum of 48 inches high.
- Side reach should be a maximum of 54 inches high.
- Work surface height should be from 28 to 34 inches above the floor.
- Knee clearance should be at least 27" high, 30" wide and 19" deep.
- Audible alarms should exceed prevailing equivalent sound level by at least 15 dB.

U.S. Department of Justice
Civil Rights Division
Disability Rights Section – NYAV
950 Pennsylvania Avenue, NW
Washington, DC 20530
(800) 514-0301
www.ada.gov

General References

American Conference of Governmental Industrial Hygienists. *Industrial Ventilation, A Manual of Recommended Practice, 24th Edition*. Cincinnati, OH: 2001.

American Conference of Governmental Industrial Hygienists. Documentation of the Threshold Limit Values and Biological Exposure Indices, Pub #0100DOC. 7th Edition, Cincinnati, OH: 2002.

ASHRAE Standards Committee. *ASHRAE Standard 110-1995 - Method of Testing Performance of Laboratory Fume Hoods (ANSI Approved)*. Atlanta: ASHRAE Publications Sales Department, 1995.

British Standards Institution. *Laboratory Fume Cupboards*. BS7258-1, 2, 3 & 4. London: 1994.

DiBerardinis, L. et al. *Guides for Laboratory Design: Health and Safety Considerations*. 3rd Edition, Wiley-Interscience, 2001.

Fleming, Diane O., Tulis, Jerry I., Richardson, J. and Vesley, Donald. *Laboratory Safety: Principles and Practices*. 2nd Edition, American Society for Microbiology, Washington, D.C.: 1995.

Furr, A. Keith, Editor. *CRC Handbook of Laboratory Safety*, 5th Edition. CRC Press, 2000.

Lewis Sr., Richard J. *Rapid Guide to Hazardous Chemicals in the Workplace*. 4th Edition, Wiley-Interscience, 2000.

McDermott, Henry. *Handbook of Ventilation for Contaminant Control*, 3rd Edition. American Conference of Governmental and Industrial Hygienists, 2001.

National Fire Protection Association. *NFPA 45 - Standard on Fire Protection for Laboratories Using Chemicals*. Quincy, MA, 2000.

National Institutes of Health, *NIH Guidelines for the Laboratory Use of Chemical Carcinogens*. NIH Publication No. 81-2385, National Institutes of Health, Bethesda, MD, 1981.

Rayburn, Stephen R. *The Foundations of Laboratory Safety, A Guide for the Biomedical Laboratory*. Springer-Verlag, New York: 1990.

Schilt, Alfred A. *Perchloric Acid and Perchlorates*. The G. Frederick Smith Chemical Company, Columbus, OH: 1979.

Scientific Equipment & Furniture Association. *Laboratory Fume Hoods Recommended Practices*, SEFA 1-2002, Garden City, NY, 2002.

U.S. Department of Justice, *28 CFR Part 36: ADA Standards for Accessible Design*. Washington, DC: 1994.

U.S. Department of Labor, Occupational Safety and Health Administration. *29 CFR Part 1910.1450, Occupational Safety and Health Standards: Occupational exposure to hazardous chemicals in laboratories*. Washington, DC: 1996.

U.S. Department of Labor, Occupational Safety and Health Administration, *29 CFR Part 1910.95, Occupational Safety and Health Standards: Occupational noise exposure*. Washington, DC: 1996.

Glossary

access opening That part of the fume hood through which work is performed; entrance or sash opening.

activated carbon filter A filter containing activated carbon media designed to trap gaseous organic compounds by adsorption or absorption.

air ejector An air-moving device that creates suction by venturi method to draw fumes through the ductwork to the atmosphere. An alternative to a blower.

airflow monitor A detection device mounted on a fume hood that alerts the operator to low airflow levels.

air foil Curved or angular member(s) at the fume hood entrance that helps to control the pattern of air moving into the hood.

air volume Quantity of air normally expressed in cubic feet per minute (CFM).

auxiliary air Supply or supplemental air delivered to a fume hood to reduce room air consumption; make-up air or add air.

auxiliary-air hood A fume hood designed with a means of providing supplemental air for the hood exhaust thereby reducing room air consumption.

baffle Panel located across the fume hood interior back which controls the pattern of air moving into and through the fume hood.

biological safety cabinet Safety enclosure with HEPA filter(s) that provides containment for airborne particulates such as infectious or carcinogenic agents; laminar flow biohazard hood. This enclosure is not a fume hood.

blower Air moving device, sometimes called a fan, consisting of a motor, impeller and housing.

by-pass Compensating opening that maintains a relatively constant volume exhaust through a fume hood, regardless of sash position, and that functions to limit the maximum face velocity as the sash is closed.

by-pass block Device that partially obstructs the by-pass opening above the sash of a by-pass hood, reducing the air volume demand.

by-pass hood A fume hood designed with openings above and below the sash to minimize fluctuations in face velocity as the sash is raised or lowered.

California hood A fume hood used to house distillation apparatus that can provide visibility from front and back or all sides, with horizontal-sliding access doors along the length

of the assembly. The hood, when connected to an exhaust system, contains and carries away fumes generated within the enclosure when doors are closed or when the access opening is limited.

canopy hood Suspended ventilating device used to exhaust heat, steam and odors. This device is not a fume hood.

capture velocity The air velocity at the hood face necessary to overcome opposing air currents, and to contain contaminated air within the fume hood.

clean bench An enclosure that directs HEPA-filtered air vertically or horizontally over the work area providing product protection. This enclosure is not a fume hood and does not provide personnel protection.

constant air volume (CAV) hood A fume hood that maintains a consistent exhaust volume. Conventional, by-pass, high performance auxiliary-air and reduced air volume hoods are examples of CAV hoods.

conventional hood A basic fume hood with an interior baffle and movable front sash.

cross draft A flow of air that blows into or across the face of the hood.

damper Device installed in a duct to control airflow volume.

dead air space Area inside a fume hood with no air movement.

distillation hood A fume hood that provides a work surface approximately 18 inches above the room floor, to accommodate tall apparatus.

downdraft hood An enclosure designed for applications involving heavier than air materials in which the blower is mounted below the work surface so that air is pulled down through a mesh surface before being exhausted to the outside. This enclosure is not a fume hood.

duct Round, square or rectangular tube or pipe used to enclose moving air.

ductless carbon-filtered enclosure An enclosure that houses filters to trap certain chemical fumes and vapors.

ductwork Duct and all the components necessary to connect pieces of duct together including adapters, reducers, elbows and couplings.

effluent Waste material (fumes, particles, smoke) discharged to the atmosphere.

explosion-proof Description for hoods or other devices with specially designed electrical components that totally contain and isolate electrical sparks from fume exposure so they cannot generate a fire or explosion.

face Front or access opening of a fume hood.

face velocity Speed of air moving into a fume hood entrance or access opening, usually expressed in feet per minute (fpm).

fan Air moving device, usually called a blower, consisting of a motor, impeller and housing.

fume scrubber An exhaust treatment device that uses water or chemical sprays to remove particles and to neutralize and dilute acids.

glove box A leak-tight chamber with glove ports and gloves for handling materials inside, a viewing window for observing, and a transfer chamber or door for loading and unloading. This enclosure is not a fume hood.

HEPA filter High-efficiency particulate air filter. A disposable extended-pleated dry-type filter with a minimum particle removal efficiency of 99.9% for thermally generated monodisperse DOP smoke particles with a diameter of 0.3 micron.

high performance hood A fume hood with containment-enhancing features that permit the hood to operate at lower face velocities to conserve energy.

HOPEC IV Hand-Operated, Positive Energy Control. Fume hood design with features that promote safety, energy efficiency and ADA compliance.

laminar flow Name applied to clean bench or biological safety enclosure that uses a smooth directional flow of air to capture and carry away airborne particles.

liner Interior lining used for side, back and top enclosure panels, exhaust plenum and baffle system of a fume hood.

make-up air Supply or supplemental air delivered to a fume hood to reduce room air consumption; auxiliary air or add air.

manometer Device used to measure air pressure differential, usually calibrated in inches of water.

modified by-pass system A method used by some variable air volume hoods whereby when the sash is lowered to a certain level, air volume is no longer reduced and some air volume enters through by-pass openings to maintain a volume great enough to adequately dilute and transport fumes.

negative air pressure Air pressure lower than ambient.

positive air pressure Air pressure higher than ambient.

reverse airflow Air movement from inside the hood toward the face of the hood.

reduced air volume (RAV) hood A fume hood that uses a sash stop and by-pass block to reduce the air volume demand so that a smaller blower can be utilized and energy savings realized.

room air That portion of the exhaust air taken from the room.

sash Movable transparent panel set in a fume hood entrance.

sash stop Device that restricts the height the sash can be raised.

service fixture Item of laboratory plumbing mounted on or fastened to laboratory furniture or fume hood intended to control the supply of piped gases and liquids for laboratory use.

static pressure Air pressure in a fume hood or duct, usually expressed in inches of water.

static pressure loss Measurement of resistance created when air moves through a duct or hood, usually expressed in inches of water.

threshold limit value-time weighted average (TLV-TWA) The time-weighted average concentration for a normal 8-hour workday or 40-hour work week, to which nearly all workers may be repeatedly exposed, day after day, without adverse affect as established by OSHA.

transport velocity Minimum speed of air required to support and carry particles in an air stream.

variable air volume (VAV) hood A fume hood that alters the exhaust volume based on demand, while maintaining a face velocity within a preset range.

velocity pressure Pressure caused by moving air in a fume hood or duct, usually expressed in inches of water.

floor-mounted hood A full-height fume hood, designed to accommodate tall apparatus and to permit roll-in of instruments and equipment.

weathercap Device used at the top of an exhaust stack to prevent rain from entering the stack end.

work surface The slab or platform, usually dished to contain spills, that supports the hood and rests atop a base cabinet or bench.

For more information, please contact us:

ExpotechUSA

10700 Rockley Road
Houston, Texas 77099
USA

281-496-0900 [voice]

281-496-0400 [fax]

E-mail: sales@expotechusa.com

Website: www.ExpotechUSA.com